

LOXEAL®

ENGINEERING ADHESIVES



TECHNICAL INFORMATION

History

Loxreal Srl is an Italian family company supplying, locally and worldwide, high quality adhesives and providing industrial solutions since the early Eighties. Our commitment is certified since 1993, when Loxreal was one of the first Italian chemical companies to achieve UNI EN ISO 9001 certification, followed by UNI EN ISO 14001 in 2011. Many of our products are certified according to international standards and regulations. Today the main focus is to develop high quality products and innovative application technologies.

Production facilities

Loxreal Italy - 20811 Cesano Maderno, MB - 20826 Misinto, MB



Offices and facilities in America, Asia and Europe

Loxreal USA Pottstown, PA



Loxreal China, Shanghai



Loxreal Spain, Madrid



From production to distribution

Loxeal integrates vertically all stages of the production chain, working on them in order to customize the product according to the clients' needs. The process that allows to deliver a very high-quality product is made of different steps:

- Research and development, fundamental to grant continuous improvement.
- Production plants are in Italy with automated production lines and highly qualified technical personnel.
- Laboratory checks to ensure that products comply with quality standards.
- Distribution on B2B channels through agents, distributors and direct customers.

Certificates and approvals

Certificates and approvals achieved over many years are the best warranty of our jobs and products quality.

UNI EN ISO 9001 - Certificates that the continuous monitoring of production process, product quality and service are key elements in our company policy.

UNI EN ISO 14001 - Certificates our commitment to environmental responsibility.

Many of our products are certified according to international standards and approvals such as DVGW, TZW, Gaz de France, WRAS, BAM, NSF, ISO 10993.

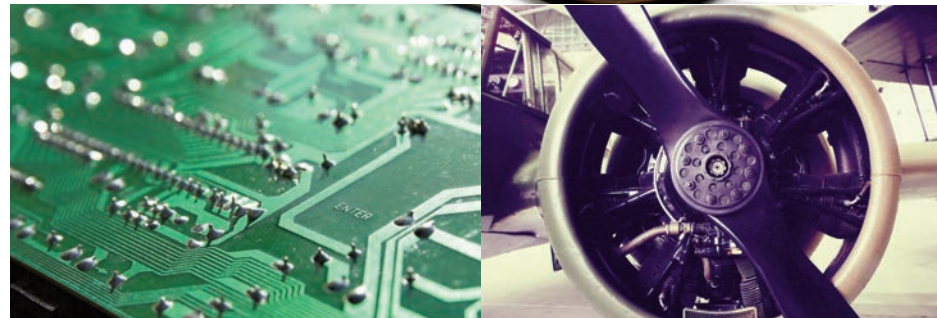
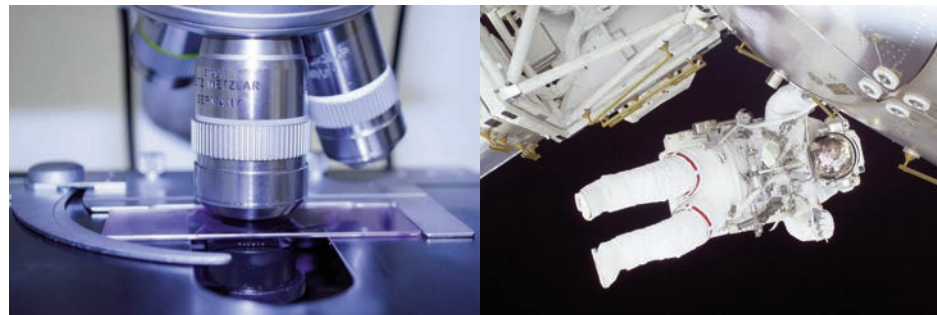

INDICE

Threadsealing	p.	1
Threadlocking	p.	2
Gasketing	p.	3
Retaining	p.	4
UV curing adhesives	p.	5
Cyanoacrylate adhesives - Istant	p.	6-7
Epoxy Adhesives	p.	8
Acrylic Adhesives	p.	9
Surface conditioners	p.	10
Complementary products	p.	10
Dosing Systems	p.	11



*****REMARK**

BROOKFIELD VISCOSITY	LOCKING TORQUE
HT = HIGHT THIXOTROPY	BOLT M10 X 20 Zn - QUALITY 8,8
MT = MEDIUM THIXOTROPY	NUT = 0,8 d
LT = LOW THIXOTROPY	STANDARD ISO 10964

F = Fluorescent: when exposed to UV light by wood lamp (black light).

Thixotropy: capability of an adhesive to reduce its viscosity when exposed to stress.

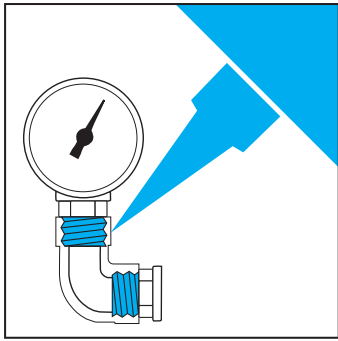

Threadsealing

Threadsealings guarantee hydraulic tightness of the threaded connections.

SUBSTRATES:

- Metal

BENEFITS:

- Replace hemp and PTFE tapes.
- Range of products with different curing time.
- Lubricate for easier assembly.
- Available in 3 grades of locking strength: low (easy to dismantle), medium (possible to dismantle), high (permanent locking).
- Maintain the initial applied torque.
- Seal to the burst pressure and to thermal expansion rates.
- Seal and lock threaded connections against pressure of gas, air, water, oils, hydrocarbons and many chemicals.
- Certified according to various international standards, e.g. DVGW, NSF, WRAS, TZW, BAM, GLOBAL MARK.

	PRODUCT	MAX DIAMETER OF THREAD MAX GAP FILLING		*** VISCOSITY 25°C mPa s (LT-MT-HT)	COLOUR	CURING TIME		*** LOCKING TORQUE N m (ISO 10964)		SHEAR STRENGTH (ISO 10123) N/mm ²	TEMPERATURE RANGE °C	APPROVALS	DESCRIPTION	
						HANDLING (min.)	FUNCTIONAL (h)	BREAKAWAY	PREVAILING					
LOW STRENGTH	15-36	2"	0,30 mm	3000-6000	LT	BLUE/F	15 - 30	1 - 3	8 - 14	4 - 8	4 - 6	-55 +180	Gas DVGW	Fluid, high temperature.
	18-10	2"	0,30 mm	17000-70000	HT	WHITE	20 - 40	1 - 3	6 - 11	2 - 5	4 - 6	-55 +150	Gas DVGW e AGA	PTFE paste, high viscosity, slow, elastic film.
	23-18	3/4"	0,15 mm	600-800	LT	BLUE/F	15 - 30	1 - 3	5 - 8	2 - 5	3 - 5	-55 +150		Fluid, for small threads.
MEDIUM STRENGTH	53-14	3/4"	0,15 mm	430-630	LT	BROWN/F	10 - 20	1 - 3	12 - 18	10 - 20	8 - 12	-55 +150	Gas DVGW	Fluid.
	55-14	2"	0,30 mm	2500-12000	MT	RED/F	10 - 20	1 - 3	12 - 18	20 - 30	8 - 12	-55 +150		Medium viscosity, general purpose.
	55-37	1 1/2"	0,25 mm	2500-4500	LT	RED/F	15 - 30	1 - 3	15 - 32	25 - 45	10 - 14	-55 +150	Gas DVGW	Flexible, high performances.
	56-03	2"	0,30 mm	5000-30000	MT	BLUE	15 - 30	1 - 3	10 - 16	12 - 20	8 - 12	-55 +150		Fill large gaps.
	58-10	2"	0,30 mm	25000-90000	HT	WHITE/F	5 - 10	0,5 - 1	18 - 25	10 - 20	6 - 13	-55 +150	Gas Gaz de France	High viscosity, fast.
	58-11	2"	0,30 mm	20000-80000	HT	YELLOW/F	15 - 30	1 - 2	18 - 24	7 - 14	6 - 13	-55 +150	Gas DVGW e AGA, Oxygen BAM, Potable water WRAS, Food NSF P1	High viscosity.
	58-12	2"	0,30 mm	20000-80000	HT	YELLOW	15 - 45	6 - 12	18 - 24	7 - 14	4 - 10	-55 +150		High viscosity, green, no risk phrases, blank MSDS.
HIGH STRENGTH	82-01		0,15 mm	220-300	LT	GREEN	2 - 5	1 - 3	20 - 35	50 - 70	20 - 30	-55 +175		Sealant/retainer, fluid, fast.
	83-05	3/4"	0,20 mm	500-1000	LT	GREEN	2 - 5	1 - 3	25 - 35	50 - 70	25 - 35	-55 +200		Fluid, for stainless steel and passivated surfaces
	83-50	3/4"	0,20 mm	400-1000	LT	GREEN/F	2 - 5	1 - 3	25 - 35	40 - 50	25 - 35	-55 +200	Gas DVGW, Potable water WRAS	High temperature.
	84-90	1 1/2"	0,20 mm	1000-1500	LT	GREEN	15 - 30	3 - 6	20 - 30	30 - 40	10 - 20	-55 +250		High temperature, up to +250°C.
	85-21	1 1/2"	0,20 mm	2600-3400	LT	GREEN/F	2 - 5	1 - 3	30 - 40	55 - 70	25 - 35	-55 +150	Gas Gaz de France	Fast, allow working tolerances.
	85-86	2"	0,30 mm	2200-4000	LT	GREEN/F	10 - 40	6 - 12	25 - 35	40 - 55	15 - 25	-55 +200	Gas DVGW, Oxygen BAM, Potable water TWZ, WRAS	High temperature.
	86-55	2"	0,30 mm	5000-8000	LT	RED/F	60 - 90	12 - 24	15 - 35	15 - 45	10 - 20	-55 +150		Delayed curing.
	86-58	2"	0,30 mm	5000-7000	LT	RED/F	30 - 60	6 - 12	35 - 40	40 - 50	15 - 25	-55 +150		High resistance, for brass.

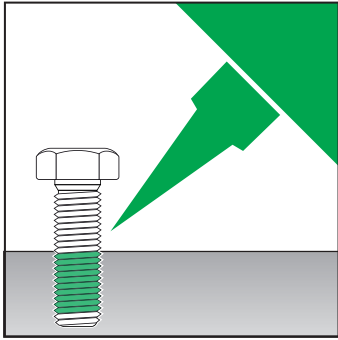

Threadlocking

Loxéal anaerobic threadlocking adhesives enable you to lock bolts, studs nuts and screws and to avoid loosening caused by stress and vibration.

SUBSTRATES:

- Metal

BENEFITS:

- Replace mechanical washers and fasteners.
- Prevent loosening caused by vibration, mechanical and thermal shock.
- Lubricate for easier assembly.
- Maintain the initial applied torque.
- Available in 3 grades of locking strength: low (easy to dismantle), medium (possible to dismantle), high (permanent locking).
- Certified according to international standards DVGW, TZW.

	PRODUCT	MAX DIAMETER OF THREAD MAX GAP FILLING		*** VISCOSITY 25°C mPa s (LT-MT-HT)	COLOUR	CURING TIME		*** LOCKING TORQUE N m (ISO 10964)		SHEAR STRENGTH (ISO 10123) N/mm ²	TEMPERATURE RANGE °C	APPROVALS	DESCRIPTION	
		HANDLING (min.)	FUNCTIONAL (h)			BREAKAWAY	PREVAILING							
LOW STRENGTH	24-18	M24	0,20 mm	800-1400	MT	PURPLE/F	15 - 30	1 - 3	5 - 8	2 - 5	3 - 5	-55 +150		Anti-vibration, general purpose.
MEDIUM STRENGTH	54-03	M24	0,20 mm	900-1500	MT	LIGHT BLUE/F	10 - 20	1 - 3	14 - 20	4 - 9	8 - 12	-55 +150		Fluid, general purpose.
	55-02	M36	0,25 mm	2500-12000	MT	BLUE	20 - 40	6 - 12	18 - 25	9 - 16	9 - 13	-55 +150		Green, no risk phrases, blank MSDS.
	55-03	M36	0,25 mm	1700-9000	MT	BLUE/F	10 - 20	1 - 3	18 - 23	9 - 16	9 - 13	-55 +200	Gas DVGW, Gaz de France, Potable water TZW	High Temperature, for oily surfaces.
	55-04	M36	0,25 mm	1500-8600	MT	RED/F	10 - 15	1 - 3	20 - 25	40 - 50	10 - 15	-55 +150		Fill large gaps, for large diameter studs.
HIGH STRENGTH	70-14	M5	0,07 mm	10-20	LT	GREEN	10 - 20	1 - 3	10 - 25	25 - 40	8 - 12	-55 +150		Capillary penetration on pre-assembled parts, fast.
	83-52	M20	0,15 mm	450-650	LT	GREEN	10 - 20	6 - 12	25 - 35	50 - 65	10 - 20	-55 +150		Green, no risk phrases, blank MSDS.
	83-54	M20	0,15 mm	450-650	LT	GREEN	10 - 20	1 - 3	25 - 35	50 - 65	15 - 20	-55 +200		General purpose, high temperature.
	83-55	M20	0,15 mm	450-600	LT	RED/F	10 - 20	1 - 3	25 - 35	50 - 65	15 - 20	-55 +150		Sealant/retainer, for oily surfaces.
	85-56	M56 2"	0,30 mm	2500-4500	LT	BLUE/F	15 - 30	3 - 6	30 - 40	40 - 50	15 - 25	-55 +150		General purpose, medium viscosity.
	86-54	M56 2"	0,30 mm	8000-24000	MT	GREEN/F	15 - 30	3 - 6	40 - 50	45 - 55	15 - 25	-55 +150		High viscosity, fast curing, fill large gaps.
86-72	M56 2"	0,30 mm	5000-28000	MT	RED	20 - 40	3 - 6	25 - 35	40 - 70	10 - 20	-55 +230	Gas DVGW	High Temperature up to +230°C.	

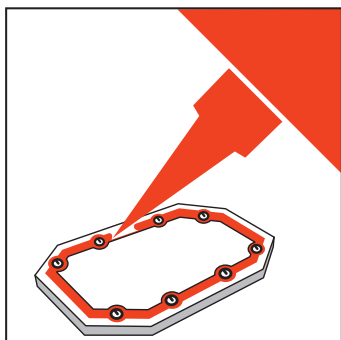

Gasketing

Gasketing Loxeal adhesives seal flat mating surfaces and join flanges on pumps, gearboxes and differential housings of any shape and dimension in an easy and effective way directly from the tube or the cartridge both vertically and horizontally.

SUBSTRATES:

- Metal, Plastic, Glass, Ceramic, Enamel, Wood

BENEFITS:

- Prevent leakage on aging (vs preformed paper, cork, or plastic gaskets).
- One adhesive replaces many pre-cut gasket shapes.
- Guarantee the parts sealing and enhance hydraulic tightness.
- Do not generate any thickness.
- Highly resistant against temperature, pressure, oils and chemicals.
- Prevent oxidation and fretting corrosion.
- Possible to dismantle with standard tools.
- Rapid cure speeds at low pressure and resistance to high temperature, up to +250°C.

Liquid gasketing

PRODUCT	CLASS OF LOCKING	MAX GAP FILLING	*** VISCOSITY +25°C Pa s	COLOUR	CURING TIME		ADHESIVE STRENGTH			TEMPERATURE RANGE °C	DESCRIPTION
					HANDLING (min.)	FUNCTIONAL (h)	SHEAR (ISO 4587) N/nm ²	TENSILE (ISO 6922) N/nm ²	IMPACT (ASTM D 950) KJ/m ²		
28-10	Low Strength	0,30 mm	17-60 HT	GREEN/F	20 - 40	3 - 6	4 - 6	2 - 4	2 - 4	-55 +150	Easy to dismantle, elastic film.
58-14	Medium Strength	0,50 mm	28-100 HT	ORANGE	15 - 30	3 - 6	5 - 10	5 - 8	3 - 5	-55 +150	General purpose.
58-31	Medium Strength	0,50 mm	70-600 HT	RED/F	10 - 20	1 - 3	8 - 13	7 - 10	4 - 7	-55 +180	Elastic film, high performances.
59-10	Medium Strength	0,50 mm	50-300 HT	RED/ORANGE	15 - 30	3 - 6	5 - 10	6 - 8	3 - 5	-55 +200	High temperature, fill large gaps.

Elastomeric & Plastic Gasket

PRODUCT	VISCOSITY +25°C Pa s	COLOUR	CURING TIME		ELONGATION AT BREAK %	TENSILE STRENGTH N/nm ²	HARDNESS SHORE A	TEMPERATURE RANGE °C	DESCRIPTION
			INITIAL STRENGTH MINUTES	BEAD ø 2 mm					
59-20	PASTY	TRANSPARENT	15 - 30	24 h	400 - 600	0,8 - 2	20 - 30	-55 +180	Odourless neutral silicone, high oil resistance.
		GREY/BLACK	15 - 30	24 h	400 - 600	0,6 - 1,5	20 - 30	-55 +180	Odourless neutral silicone, high oil resistance.
59-30	PASTY	RED/BLACK	10 - 20	24 h	300 - 600	1,5 - 2,5	25 - 35	-60 +250	High temperature silicone.
59-40	PASTY	TRANSPARENT	10 - 20	24 h	80 - 150	1 - 2	40 - 50	-40 +90	MS polymer, odourless, paintable, UV rays resistant.
		GREY	10 - 15	24 h	150 - 350	1,2 - 1,8	40 - 60	-40 +90	MS polymer, odourless, paintable, UV rays resistant.

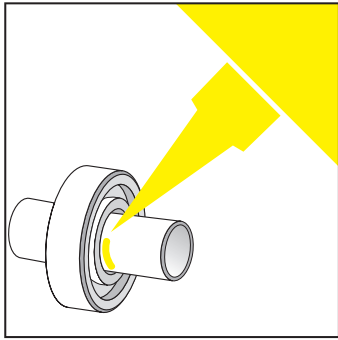

Retaining

Retaining anaerobic Loxeal adhesives lock and fit cylindrical assemblies and increase the load carrying capacity.

SUBSTRATES:

- Metal

BENEFITS:

- Allow high strength cylindrical assemblies like: bearings, pulleys, pivots, bushes.
- Replace welding and mechanical retainers.
- Allow larger machining tolerances, reducing manufacturing costs.
- Lubricate for easier assembly.
- Seal the joint preventing fretting corrosion.
- Can seal together different materials.
- Ensure high transmission strength.
- High temperature resistance.

	PRODUCT	MAX DIAMETER OF THREAD MAX GAP FILLING		*** VISCOSITY 25°C mPa s (LT-MT-HT)		COLOUR	CURING TIME		*** LOCKING TORQUE (ISO 10964) N m		SHEAR STRENGTH (ISO 10123) N/mm ²	TEMPERATURE RANGE °C	APPROVALS	DESCRIPTION	
							HANDLING (min.)	FUNCTIONAL (h)	BREAKAWAY	PREVAILING					
MEDIUM STRENGTH	53-11	M20	0,12 mm	400-650	LT	YELLOW/F	10 - 20	1 - 3	11 - 20	15 - 25	8 - 12	-55 +150		General purpose.	
HIGH STRENGTH	82-13	M12	0,10 mm	120-180	LT	GREEN/F	30 - 60	12 - 24	15 - 25	35 - 45	15 - 30	-55 +150		Fluid, for precise joints, slow curing.	
	82-21	M12	0,10 mm	120-180	LT	GREEN	5 - 10	1 - 3	24 - 35	50 - 60	17 - 22	-55 +150		Fluid, for precise joints, fast curing.	
	82-33	M12	0,10 mm	120-180	LT	GREEN	2 - 5	1 - 3	20 - 30	45 - 55	17 - 22	-55 +150		For oily surfaces.	
	83-03	M20 3/4"	0,20 mm	800-1200	LT	GREEN/NF	2 - 5	1 - 3	25 - 35	50 - 70	25 - 35	-55 +200	Gas Gaz de France	Fluid, very fast curing, high temperature.	
	83-21	M20 3/4"	0,15 mm	400-600	LT	GREEN	2 - 5	1 - 3	25 - 35	50 - 70	25 - 35	-55 +175	Oxygen BAM	General purpose, fast curing high temperature.	
	85-02	M36 1 1/2"	0,20 mm	3000-4000	MT	GREEN/F	1 - 4	1 - 3	30 - 40	55 - 70	25 - 35	-55 +175		Very fast curing, high temperature.	
	85-21	M36 1 1/2"	0,20 mm	2600-3400	LT	GREEN/F	2 - 5	1 - 3	30 - 40	55 - 70	25 - 35	-55 +150	Gas Gaz de France	Fast, allow working tolerances.	
	85-61 UV	M36 1 1/2"	0,20 mm	3000-4000	LT	BLUE/F	5 - 10	1 - 3	30 - 40	50 - 60	20 - 25	-55 +150		Double curing: anaerobic and UV.	
	86-21		2"	0,30 mm	7000-30000	TIXO	GREEN/F	1 - 4	1 - 3	30 - 40	50 - 70	25 - 30	-55 +150		Hhigh viscosity, fill large gaps, fast curing.
	86-86	M56	2"	0,30 mm	5000-35000	MT	GREEN/F	20 - 40	3 - 6	25 - 35	40 - 70	10 - 20	-55 +230	Gas DVGW	High temperature.
89-51		2"	0,30 mm	60000-720000	HT	SILVER	15 - 30	3 - 6	40 - 45	15 - 20	25 - 30	-55 +150		Repair damaged shafts.	



UV curing adhesives

Loxéal UV curing adhesives cure in a short time in presence of a UV light source, if at list one of the surfaces is transparent. They create a very tough plastic film.

SUBSTRATES:

- Glass/glass, Glass/metal, Transparent plastic (PC, ABS, PMMA)

BENEFITS:

- Usually colorless, they are designed to bond clean, transparent and not yellowing junctions.
- They're suitable for coating, potting and sealing.
- They are extremely reactive, they start curing as the sun UV light activates the photo initiators.
- Different kind of UV lamps are available for industrial use, such as mercury vapor lamps and led lamps.
- Some of Loxéal UV curing adhesives can be used for medical devices application.

	PRODUCT	VISCOSITY (+25°C Pa s)	GAP FILLING mm	CURING TIME (seconds)	TENSILE STRENGTH (ASTM D 2095-69) N/mm ²	DESCRIPTION
GLASS	30-20	2200 - 2900	0,03 - 1,5	6 - 10	10 - 14	Transparent, fast curing, general purpose, decorative objects.
	30-21	600 - 1300	0,03 - 1,5	8 - 15	10 - 14	Tough, bonding on edges.
	30-22	5500 - 7500	0,03 - 2	6 - 10	8 - 12	Transparent, high viscosity, general purpose.
	30-23	50 - 100	0,03 - 1,5	8 - 15	10 - 14	Very fluid, for plain surfaces.
	30-24	2200 - 2900	0,03 - 2	6 - 10	12 - 16	Rigid film, high resistance, decorative objects.
	30-30	500 - 800	0,03 - 1,5	5 - 10	8 - 14	Clarity overtime, adhesive excess easy to clean.
	30-33	1000 - 2000	0,03 - 1,5	5 - 15	6 - 10	Clarity overtime, tough.
	30-34	2500 - 3500	0,03 - 1,5	6 - 10	8 - 14	Clarity overtime, decorative objects.
	30-35	5000 - 8000	0,03 - 1,5	5 - 10	8 - 12	Clarity overtime, resistant to humidity.
	30-36	5000 - 8000	0,03 - 2	5 - 10	8 - 12	Clarity overtime, tough, fill large gaps.
	30-37	2200 - 2900	0,03 - 1,5	6 - 10	6 - 10	Flexible, for bonding glass with metallic platics.
	30-38	20000 - 30000	0,03 - 2	5 - 10	5 - 10	Clarity overtime, high viscosity, fill large gaps.
	30-60	GEL	0,03 - 2,5	8 - 15	4 - 8	Gel, transparent, for vertical bonding.
PLASTIC	30-11	200 - 300	0,03 - 0,20	6 - 55	-	Fluid for medical plastic, approved for medicals ISO 10993.
	30-12	200 - 400	0,03 - 0,20	6 - 30	-	Specific for thermoplastic.
	30-14	1000 - 2000	-	120 - 240	-	Specific for PMMA.
	30-27	90 - 150	0,03 - 0,20	6 - 10	-	Specific for medical needles, approved for medicals ISO 10993.
	30-83	1000 - 1600	0,03 - 1	3 - 4	-	Encapsulation, tack-free.
	3355	80000 - 120000 THIXO	0,03 - 0,20	3 - 5	5 - 10	High viscosity, flexible film.



Cyanoacrylate adhesives - Istant

The Cyanoacrylate range Loxeal Istant is developed to bond quickly a huge variety of substrates. They cure by reacting to small traces of moisture on substrates' surfaces.

SUBSTRATES:

- Metal, Plastic, Rubber, Paper, Wood and Cork.
- In combination with Primer 7:
- Polyethylene, Polypropylene, EPDM, Silicone rubber and PTFE.

	PRODUCT	SPECIFIC GRAVITY	VISCOSITY (+25°C mPa s)	GAP FILLING (microns)	SPEED OF CURE (*)	TENSILE STRENGTH (ISO 6922) N/mm ²	SHEAR STRENGTH N/mm ²	DESCRIPTION
METHYL	14	1,10	80 - 150	10 - 100	2	25 - 30	20 - 25 (1)	Fluid, high resistance, delayed curing, for metals.
	17	1,19	1200 - 1800	10 - 200	1	25 - 30	18 - 25 (1)	High viscosity, high resistance, delayed curing, for metals.
ETHYL	23	1,06	40 - 80	10 - 60	3	12 - 25	13 - 18 (2)	Fluid, general purpose.
	25	1,10	350 - 450	10 - 150	3	15 - 23	13 - 20 (1)	Medium viscosity, general purpose.
	27	1,10	1200 - 1800	10 - 200	2	18 - 25	13 - 18 (1)	High viscosity, general purpose, fill large gaps.
	32	1,10	5 - 10	10 - 40	5	12 - 25	13 - 18 (2)	Difficult to bond rubber and plastic, very fast curing.
	34	1,10	10 - 30	10 - 100	5	12 - 25	13 - 18 (2)	Difficult to bond rubber and plastic, very fast curing.
	41	1,10	5 - 10	10 - 40	5	18 - 25	13 - 18 (1)	Fluid, difficult to bond substrates, very fast curing.
	43S	1,06	80 - 150	10 - 150	5	15 - 25	15 - 20 (1)	Universal, high temperature, approved for Food NSF P1.
	45	1,06	600 - 1200	10 - 150	4	12 - 25	12 - 20 (1)	High viscosity, difficult to bond substrates.
	47	1,08	GEL	10 - 300	2	18 - 25	13 - 18 (1)	Gel, high temperature, approved for Food NSF P1.
	48	1,05	2000 - 2500 THIXO	0,5 mm	2	18 - 25	13 - 18 (1)	Fluid gel, vertical bonding porous surfaces.

(1) ISO 4587 Standard

(2) ISO 10123 Standard

(*) Relative setting time (5= max, 1 = min.)



BENEFITS:

- Curing in seconds at room temperature.
- Allow high resistance in a short time.
- Solvent free.
- Allow neat assembly without mechanical means (rivets, screws, welding).
- Easy dispensing either manually or with dosing systems.
- Three different chemical bases for specific needs:
 - Methyl for metals
 - Ethyl as universal and in special modified versions
 - Alcoxy, no blooming - odour free
- Can resist to high temperature.

	PRODUCT	SPECIFIC GRAVITY	VISCOSITY (+25°C mPa s)	GAP FILLING (microns)	SPEED OF CURE (*)	TENSILE STRENGTH (ISO 6922) N/mm ²	SHEAR STRENGTH N/mm ²	DESCRIPTION
ALCOXY	60R	1,06	3 - 10	10 - 30	1	10 - 20	14 - 22 (1)	Delayed curing infiltrant for better penetration, for 3D printing.
	61	1,06	10 - 20	10 - 40	1	10 - 20	14 - 22 (1)	Fluid, odourless, no blooming.
	63	1,07	80 - 150	10 - 150	1	10 - 25	12 - 22 (1)	General Purpose, odourless, no blooming.
	67	1,1	1000 - 1500	10 - 200	1	10 - 25	12 - 22 (1)	High viscosity, odourless, no blooming.
MODIFIED	29	1,06	500 - 1500	10 - 200	1	18 - 25	13 - 18 (1)	Elastomeric, black, general purpose.
	37	1,05	1000 - 2000	10 - 200	3	12 - 25	16 - 20 (1)	High viscosity, flexible, high impact resistant.
	73	1,06	100 - 200	10 - 150	2	12 - 25	15 - 25 (1)	Tough and flexible, high temperature.
	74	1,06	100 - 200	10 - 150	2	12 - 25	15 - 25 (1)	High temperature, black, tough and flexible.
	75	1,10	4000 - 5000	10 - 250	2	12 - 25	15 - 25 (1)	High viscosity, tough, high performances, general purpose.
	77	1,10	2000 - 4000	10 - 250	2	12 - 25	15 - 25 (1)	High viscosity, tough and flexible, black, high performances, general purpose.
HIGH TEMPERATURE	52	1,06	80 - 110	10 - 150	2	18 - 25	18 - 25 (1)	Fluid, resistant up to 180°.
	55	1,06	600 - 1000	10 - 200	2	18 - 25	18 - 25 (1)	Medium viscosity, resistant up to 130°.

(1) ISO 4587 Standard

(2) ISO 10123 Standard

(*) Relative setting time (5= max, 1 = min.)

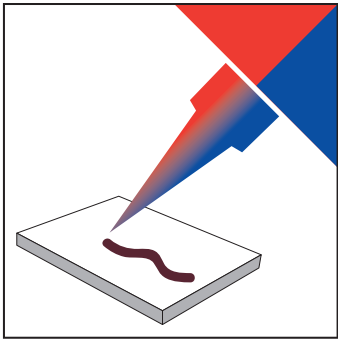

Epoxy Adhesives

Loxéal Epoxy Adhesives are structural adhesives with high mechanical resistance. The 2k resins cure by mixing the two components (resin and hardener), usually at room temperature. The modified 2k epoxy resins are designed for applications that require flexible bonding and sealing. 1k epoxy resins are the highest performant adhesives as for mechanical, thermal and chemicals resistance, they cure by means of heating.

SUBSTRATES:

- Metal, Composite, Glass, Ceramic, Wood, Stone, Plastic.

BENEFITS:

- High mechanical resistance.
- Can bond different materials.
- Different curing times available.
- Heating shorten the curing process.
- Fill large gaps.
- Highly resistant against humidity and chemicals.
- Available in a full color range: from transparent for glass and design to black for carbon fiber.

	PRODUCT	COLOUR	VISCOSITY (+25°C Pa s)	HANDLING TIME (+25°C) MINUTES	FUNCTIONAL CURE TIME (+25°C)	SHEAR STRENGTH (ISO 4587) N/mm ²	PEEL STRENGTH (ISO 4578) N/25 mm	DESCRIPTION
TWO-PART Viscosity = (1) Resin - (2) Hardener (*) Time detected on a 2 g total mass mixture A + B (**) With hot curing for 60 minutes at +80°C	31-10	AMBER	12-18 (1) / 10-25 (2)	90 - 150 (*)	12 - 24 h	12 - 14	10 - 25	Tough, 120 minutes.
	31-40	COLOURLESS	12-18 (1) / 15-30 (2)	10 - 20 (*)	30' - 40'	10 - 12	4 - 20	Tough, transparent, 15 minutes.
	31-42	COLOURLESS	12-18 (1) / 15-30 (2)	3 - 8 (*)	20' - 30'	12 - 14	4 - 20	Tough, transparent, 5 minutes.
	32-43	TRANSLUCENT	30-180 (1) / 50-200 (2)	7 - 10 (*)	10' - 20'	10 - 14	-	General purpose, fast curing even at low temperature.
	34-15	IVORY	20-35 (1) / 20-50 (2)	15 - 35 (*)	12 - 24 h	5 - 10	40 - 70	Tough and flexible, general purpose, impact resistant, 30 minutes.
	35-44	COLOURLESS	10-20 (1) / 14-24 (2)	10 - 20 (*)	40' - 60'	5 - 9	25 - 60	General purpose, tough and flexible, high peel resistant.
	36-10	AMBER	14-28 (1) / 10-25 (2)	90 - 150 (*)	12 - 24 h	12 - 18	25 - 40	Flexible and tough, 120 minutes.
	3636	GREY	50-100 THIXO (1) / 100-200 THIXO (2)	50 - 80 (*)	72 - 96 h	15 - 25	60 - 80	Tough, high viscosity, slow curing.
	4401	GREY	60-120 THIXO (1) / 50-100 THIXO(2)	15 - 25	24 - 36 h	20 - 30	150 - 300 (**)	Tough, high temperature.
	4428	IVORY	25-35 (1) / 15-20 (2)	10	24 - 36 h	18 - 22	150 - 200	Fast curing, high temperature, for composites bonding.
	4429	BLACK	100 THIXO (1) / 20-30 THIXO (2)	120	24 - 36 h	18 - 22	200	High viscosity, non-sag, slow curing, high temperature, for carbon fiber.
	EPOSTICK	AMBER	PASTE	5 - 7	15' - 25'	4 - 6	-	Plastic putty designed for fast or emergency maintenance and repair.
HYBRID TWO-PART	4807	GREY	25000-45000 THIXO / 1500-3000	10 - 20	7 days	4 - 10	60 - 80	Maximum flexibility, for bonding together different materials.
	4820	BLACK	20000-50000 / 200-300	25 - 50	72 h	4 - 7	-	Self-levelling, maximum flexibility, general purpose.
	4821	BLACK	PASTE THIXO	10 - 15	72 h	4 - 7	60 - 80	High viscosity, maximum flexibility, general purpose.
	4826	IVORY	PASTE THIXO	-	72 h	1 - 2	-	Self-extinguishing, thermal conductive, high temperature.

	PRODUCT	COLOUR	VISCOSITY (+25°C Pa s)	HANDLING TIME AT + 150°C MINUTES	SHEAR STRENGTH (ISO 4587) N/mm ²	PEEL STRENGTH (ISO 4578) N/25 mm	TEMPERATURE RANGE °C	DESCRIPTION
SINGLE-PART (•) Curing time depends on temperature	4500	GREY	800 - 3800 THIXO	30 - 45 (•)	20 - 30	80 - 120	-40 +180	Tough, high viscosity, for vertical bonding, high performances.
	4580	GREY	150 - 250 THIXO	45 - 60 (•)	18 - 25	80 - 120	-40 +180	Tough, self-levelling, fluidify while curing.
	4620	WHITE	15 - 30	30 - 45 (•)	18 - 25	-	-40 +180	Fluid, tough, self-levelling.
	4680	IVORY	60 - 100	15 - 30 (•)	20 - 25	-	-40 +180	High impact strength, fluidify while curing for ferrites and magnets.
	4690	BLACK	200 - 300 THIXO	45 - 60 (•)	18 - 25	80 - 150	-40 +180	Tough, non-sag, high performances.
	4700	AMBER	8 - 12	60-90 (a+90°C)	15 - 25	-	-40 +180	Self-levelling, cure at low temperature.
	4780	BLACK	400 - 600 THIXO	30 - 45 (•)	15 - 25	-	-40 +180	High viscosity, thermal conductive.

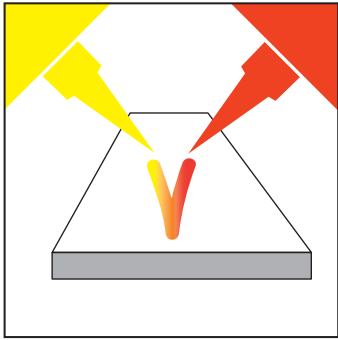

Acrylic Adhesives

Loxéal Acrylic Adhesives are structural Adhesives with high peel and impact strength. They assure high resistance against chemicals and good resistance against heat.

SUBSTRATES:

- Metal, Glass, Ceramic, Plastic.

BENEFITS:

- Greatly increase in design possibilities to bond a wide variety of substrates.
- Suitable for materials with different thermal expansion coefficient.
- Shocks and vibrations resistant.
- Chemical reaction can start in different ways:
 - Mixing by static mixer
 - Bead on bead
 - At contact (with liquid activator)

	PRODUCT	VISCOSITY (+25°C mPa s)	HANDLING TIME (minutes)	FUNCTIONAL CURE (minutes)	SHEAR STRENGTH (ISO 4587) N/mm ²	PEEL STRENGTH (ISO 4578) N/25 mm	JOINT THICKNESS mm	DESCRIPTION
ACTIVATED	30-55 (+Att. 20)	30000 - 60000 THIXO	1 - 4	30 - 60	15 - 25	85 - 100	0,05 - 1	High viscosity, general purpose.
	33-00 (+Att. 20)	45000 - 80000 THIXO	1 - 4	30 - 60	15 - 30	45 - 65	0,05 - 1	Medium viscosity, general purpose.
	3439 (+Att. 20)	600 - 1000	20-50 seconds	10 - 20	20 - 30	85 - 100	0,05 - 0,2	Fluid, high temperature, high resistance.
	3459 (+Att. 20)	15000 - 25000 THIXO	20-40 seconds	10 - 20	20 - 30	85 - 100	0,05 - 0,2	Gel, high temperature, high resistance.
BEAD ON BEAD	33-47 (A+B)	5000 - 12000	1 - 3	30 - 60	8 - 20	45 - 65	0,05 - 0,5	Fluid, general purpose.
	3592 (A+B)	10000 - 20000 (A) / 3500 - 5500 (B)	<1	10 - 20	20 - 25	-	0,05 - 1	Fast curing for ferrites and magnets.
MIXING	3362	3000 - 4000 (A) / 4000 - 5000 (B)	4 - 7	10 - 12	15 - 20	-	0,50	Low odour, for plastic, high performances.
	3452	4000 - 5000 (A) / 4000 - 5000 (B)	2 - 3	8 - 10	19 - 21	-	0,50	Low odour, for metal, high performances.
	3460	THIXO (A) / 15000 - 30000 (B)	2 - 4	24 hours	>4	-	1	Fast, for polyolefins (PE, PP, ...).
	3461	THIXO (A) / 15000 - 30000 (B)	5 - 8	36 - 48 hours	>4	-	1	Slow, for polyolefins (PE, PP, ...).

Polyurethane Adhesives

PRODUCT	VISCOSITY (+25°C mPa s)	HANDLING TIME (minutes)	FUNCTIONAL CURE (hours)	SHEAR STRENGTH (ISO 4587) N/mm ²	PEEL STRENGTH (ISO 4578) N/25 mm	JOINT THICKNESS mm	DESCRIPTION
33-26	4000 - 8000 THIXO (A) / 3000 - 6000 THIXO (B)	4 - 8	24 - 48	10 - 20	-	-	Fast curing, resistant to water, for rigid materials.
33-28	4000 - 8000 THIXO (A) / 3000 - 6000 THIXO (B)	15 - 20	24 - 48	10 - 15	-	-	Slow curing, resistant to water, for rigid materials.

Surface conditioners and complementary products



SURFACE CONDITIONERS

CATEGORY	PRODUCT	APPROVALS	DESCRIPTION
For cyanoacrilates	Primer 7		Primer For Polyolefins.
For cyanoacrilates	Activator 9		For difficult and porous surfaces, no-blooming.
For cyanoacrilates	Remover CR1		Remover for cured adhesives.
For cyanoacrilates	Remover CR2		Remover for cured adhesives, non-flammable.
For silicone	Remover CR5		Remover for cured adhesives.
For anaerobics	Activator 11		Activator, shorten curing time.
For anaerobics	Activator 17		Activator, for passive surfaces.
For anaerobics	Activator 18		Activator, non-flammable.
For acrylics	Activator 21		Activator, shorten curing time.
Cleaner	10		Cleaner, degreaser.

COMPLEMENTARY PRODUCTS

CATEGORY	PRODUCT	APPROVALS	DESCRIPTION
Silicone grease	Grease 4	Food NSF H1, potable water TZW	Waterproof, lubricant, PTFE based.
Silicone grease	Grease 9	Food NSF H1, potable water TZW	Waterproof, lubricant.
Silicone oil	Oil 1000	Potable water WRAS	Anti-adhesive, lubricant for metal plastic and rubber.
Silicone oil	Oil 12500		High viscosity anti-adhesive, lubricant for metal plastic and rubber.

Dosing Systems



DE1

Electro Pneumatic Dosing Unit

Electro Pneumatic Dosing Unit (time-pressure) for Anaerobic and Cyanoacrylate Adhesives. Including Control unit, Reservoir (with empty level sensor), Valve, Dosing nozzle, actuated by Foot Switch or metal part Sensor. Suitable for PLC connections, equipped with end cycle alarm Sensor. Tubing is made by PE and PTFE flexible hoses



DE3

Pneumatic Dosing Unit

Pneumatic Dosing Unit for manual dispensing of Anaerobic and Cyanoacrylate Adhesives. Equipped with foot switch dispensing valve. It does not require electrical power supply and is suitable for use in spark proof / flame proof environments.



DE3M

Pneumatic Dosing Unit

Pneumatic Dosing Unit for manual dispensing of Anaerobic and Cyanoacrylate Adhesives. Equipped with hand actuated dispensing valve. It does not require electrical power supply and is suitable for use in spark proof / flame proof environments.



DE4E

Syringe Dosing Unit

Precise control time/pressure. Syringe terminal used as reservoir. Micro drops dispensing. Venturi technology to avoid dripping from syringe. Multipurpose dosing unit for different liquid products.

LOXEAL[®]
ENGINEERING ADHESIVES

Loxeal Srl

Via Marconato, 2 - 20811 Cesano Maderno MB - Italia

Tel. +39.0362 5293.1 - Fax +39.0362 524225

www.loxeal.com